

Window and door catalogue

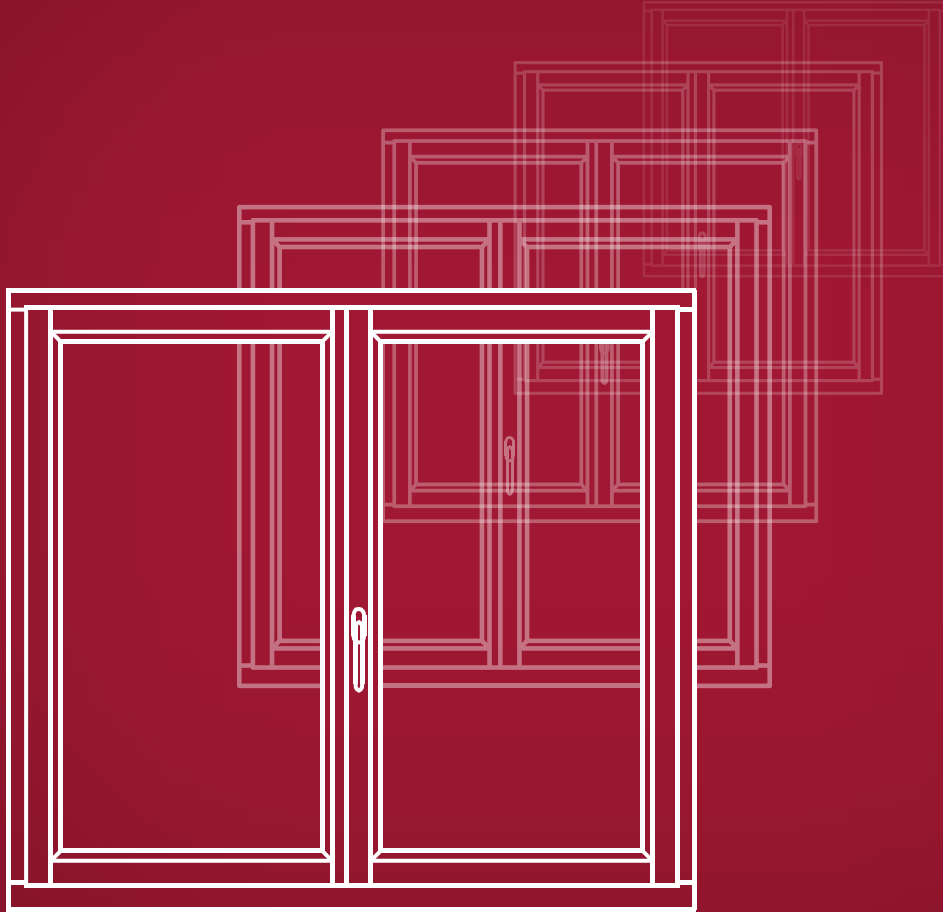

Quality | Security | Prestige | Comfort



...you will understand the difference.



Tradition of Quality since 1969.

Why UWE?

Because **UWE** have been building up their brand since 1969. In that time we have quenched the dreams of our numerous customers in Poland, Europe and worldwide. Bertrand is a renowned manufacturer of windows, doors and curtain walls. We are very proud to have earned the respect of investors in a variety of sectors: residential, commercial, historical restoration, and even the most demanding field of passive and energy efficient architecture.

What is the highest quality of UWE products a result of?

The highest quality of our products is achieved by the use of the most up-to-date technologies and continuous investments into R&D. Being one of the few manufacturers in Poland to have successfully introduced modern solutions into the market making us a pioneer of innovation and development within this sector. The quality, safety and comfort of our products are confirmed by numerous prestigious awards and certificates.

Why is UWE'S offer so comprehensive?

So you don't waste any of your precious time. You can choose from a wide range of materials: PVC systems, variety of timbers ranging from traditional pine to exotic species from around the world, aluminum systems as well as composite systems of PVC-aluminum and timber-aluminum. To complement our range of windows and doors you can choose from a vast spectrum of accessories e.g. roll-er-shutters, venetian blinds, insect screens, shutters, garage doors or even marquises or full glass constructions. We also offer numerous modern control systems e.g. radio, internet or biometrics.



Where to start?

Call us, send us an email or visit us
...you will understand the difference.

www.uwewindowsanddoors.com

Contact information on rear of catalogue.

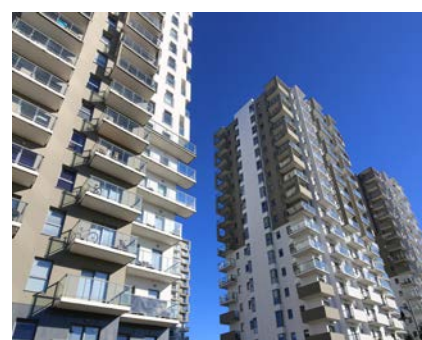
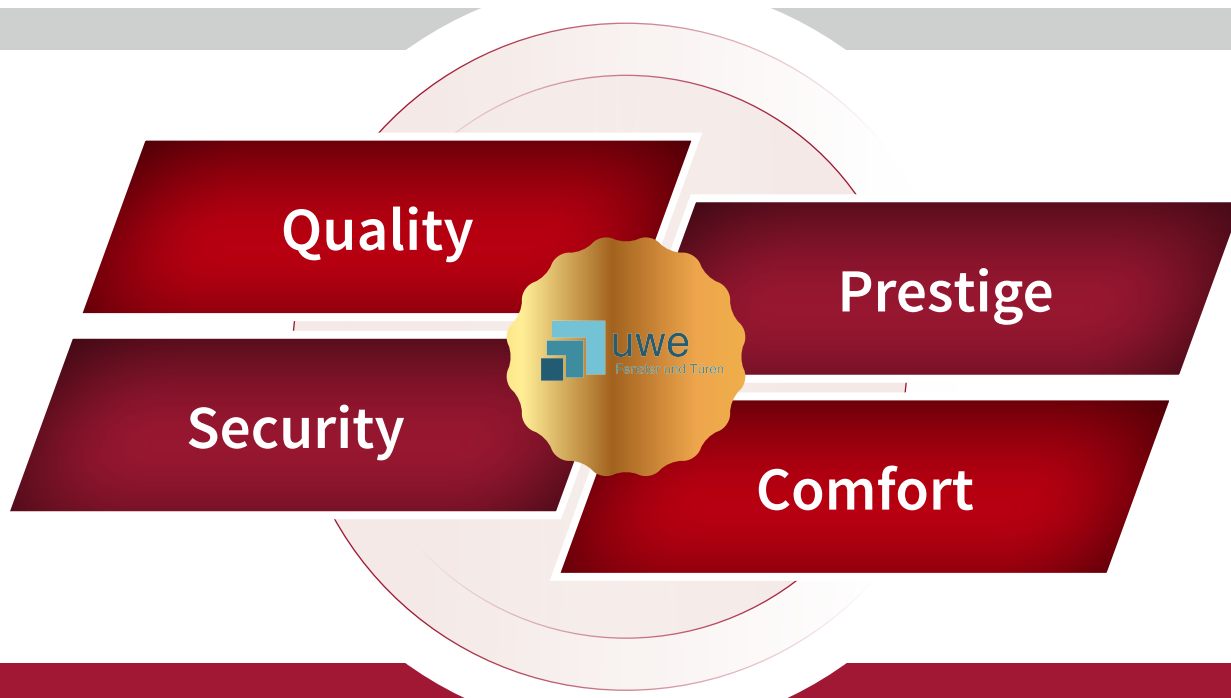

PVC Windows



- Profile systems: PVC, PVC-aluminum
- Exceptional thermal and acoustic performance
- Variety of colours, wood grain foils, acryl-colour, dual colour, painting with metallic colours
- High security standard (3-4 window keepers as standard)
- Variety of construction options
- Dual or triple gasket systems
- Wide range of glazing options: double/triple, security, sun-protection, tinted



BB-Line 82 / BB-Line 83
Construction depth: 81 mm. 6/7 chamber system.



Kombisystem / Kombisystem Alu
6 chamber system, construction depth: 83 mm.
Aluminum cladding. Triple gasket system.
Available also with optional external aluminum cladding.



Trend
5/6 chamber system, construction depth: 74 mm.



Quantix... even more light.

- Slimline profiles allow for more natural light inside the house
- 6-chamber system with a frame depth of 83 mm
- Slimline profile, combined frame and sash height only 103 mm
- Slimline floating mullion (106 mm) with centrally located handle
- Can incorporate glazed units up to 54 mm
- 3 layers of sealing
- Large variety of colours (acryl colour, wood grain foils, painting)
- Greater stability of window possible with the incorporation of STV technology



Quantix
Frame depth 83 mm.

Kubus

The modern design system provides more natural light inside the house, the height of frame and sash combination is only 100 mm!

Symmetry, geometric style and hidden sash form the basis of the system.

The complete absence of frame gaskets allows for ease of maintenance. An innovative stepped frame forms a multichambered warm junction.



Kubus
Frame depth 83 / 100 mm.
High thermal and acoustic performance, U_w from 0.68 W / m²K.

*For a reference window 1230 mm x 1480 mm with $U_g=0.5W/m^2K$ glass

PVC colours

Acrylcolor

Acrylcolor: is not a painted coating or a laminate - **is** a co-extrusion of two molten materials - **is** approximately 0.5 mm thicker than a single layer of paint - **is** scratchproof and durable - **is** inseparably fused with the profile - **is** resistant to flaking and chipping - **is** easy-care and low maintenance. **Note!** Colour code similar to RAL:

Standard colours for systems:

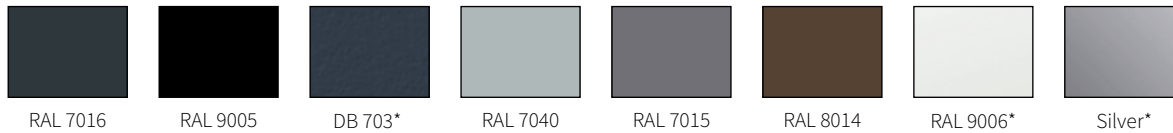

Extended colour palette available on request.

PVC painting:

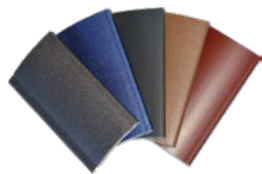

[NEW!]

PVC painting with highly durable metallic colours. The special Anti-Heat coating reduces solar energy absorption to prevent overheating of window and door profiles.

Wood Grain Foils

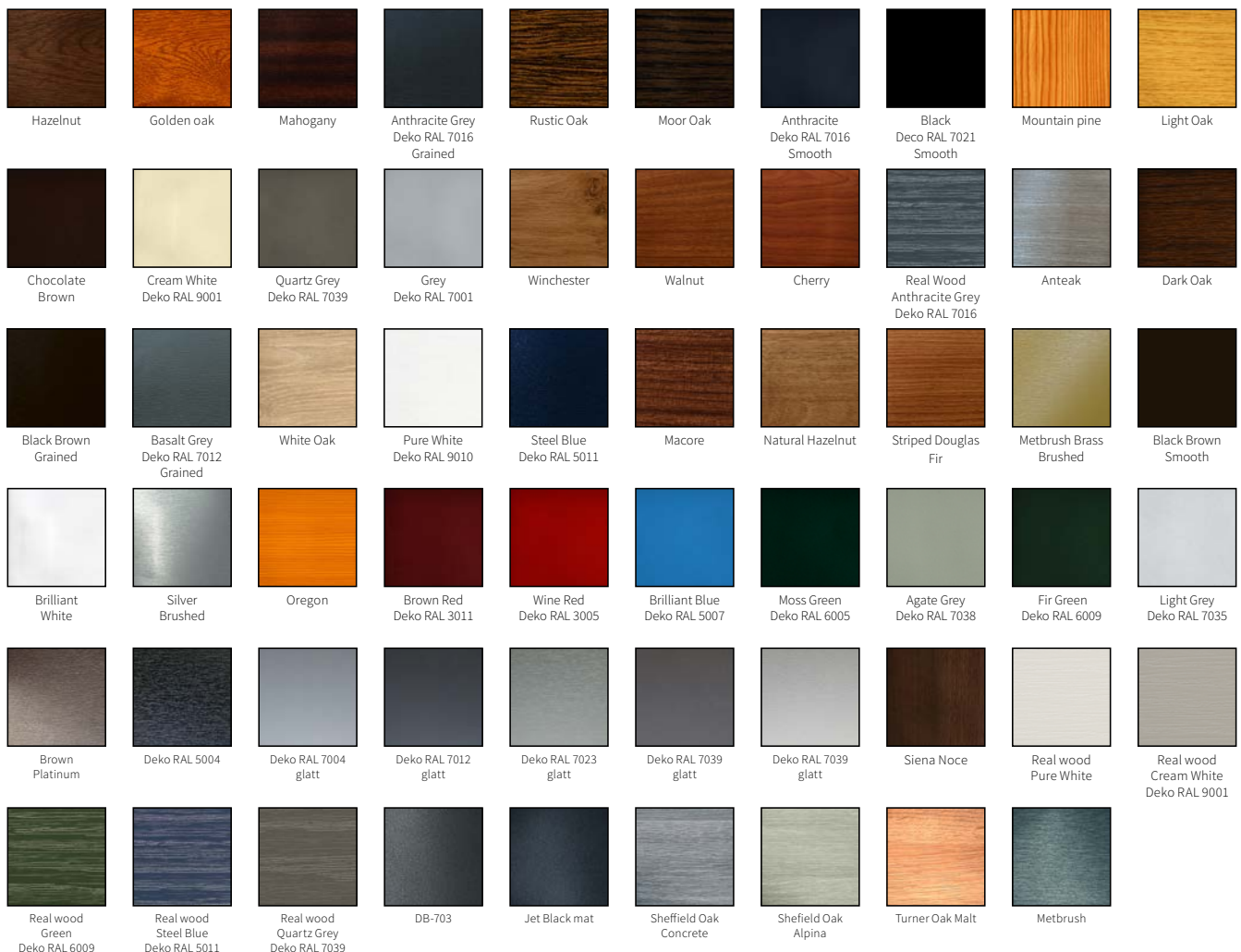

* metallic colours

NOTE! The printed representations of the foils may visually differ from the actual product.

Timber Windows

EXCEPTIONAL U_w *
from **0,81**
 W/m^2K

- Timber profile systems of various construction depths (68 mm – 112 mm)
- Wide selection of wood types from basic pine, spruce, meranti and oak to exotic zebrano, padouk, iroko, wenge and many more
- Variety of timber finishes e.g. brushing, sandblasting, oil-soaking
- Full RAL/NCS palettes, dual colour, transparent finishes, 'untreated timber' look, painting with metallic colours
- Aluminum or timber window drip profiles
- Double or triple glazing
- Warm spacer



Systems with depth 68 mm



Softline Elegant
Optional wooden drip.



Softline Perfect
Standard Softline drip.



Softline Retro
Standard Softline drip.

Systems with depth 78 mm



Softline Elegant XL
Standard Softline drip.



Softline Perfect XL
Optional Classic drip.



Softline Retro XL
Optional wooden drip.

Systems with depth 92 mm



Strongline Master
Optional Classic drip.



Strongline Retro
Optional wooden drip.

Available drip options:



• aluminum Softline



• wooden

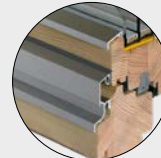

• aluminum Classic (Softline / XL)



• aluminum Classic (Strongline)

*For a reference window 1230 mm x 1480 mm with $U_g=0.5W/m^2K$ glass



Colours

We have a wide colour palette for transparent timber finishes and can also finish timber in any standard RAL or NCS colour (non-transparent). Windows can also be ordered with alternative colours inside and outside or with individual components of varying colours. The use of transparent or semi-transparent finishes greatly enhances the natural beauty of timber.

New standard colour palette:



Metallic colours:

Painting with highly durable metallic colours. The special Anti-Heat coating reduces solar energy absorption to prevent overheating of window and door profiles.

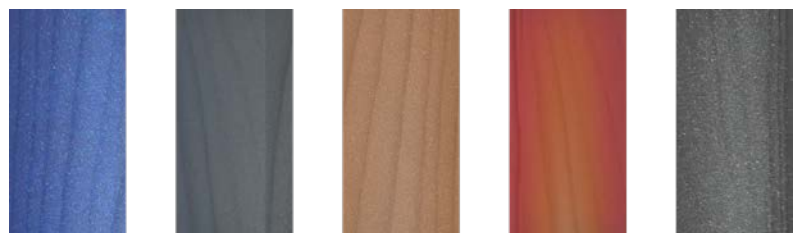

NOTE! The printed representations of the colours samples may visually differ from the actual product.

Timber-aluminum Windows

- Profile systems of various construction depths (Standard - 65 mm, XL - 75 mm, MAX - 92 mm) enlarged by the depth of aluminum cladding
- Wide selection of wood types from basic pine, spruce, meranti and oak to exotic zebrano, padouk, iroko, wenge and many more
- Variety of timber finishes e.g. brushing, sandblasting, oil-soaking
- Full RAL/NCS palettes, dual colour, transparent finishes, 'untreated timber' look
- Wide selection of aluminum cladding
- Variety of aluminum cladding finishes: wood grain finish, structural coating, brass, bronze, rust imitations
- Double or triple glazing
- Warm spacer



[NEW!]

Infinity Alu / XL
Modern hidden sash system.
An optimal alternative for wooden windows.



[NEW!]

Alutrend Smart / XL
Perfect for modern architecture with fashionable design
and very good utility performance.



Alutrend Classic / XL / MAX
Simple shape of aluminum cladding.



Alutrend Linear / XL / MAX
External face of the sash is flush with frame.



Alutrend Integral / XL / MAX
Hidden sash system.



Alutrend Quadrat / XL / MAX
Modern aluminum cladding.



Alutrend Quadrat FB / XL / MAX
Modern aluminum cladding, external face of the sash
is flush with frame.



Standard

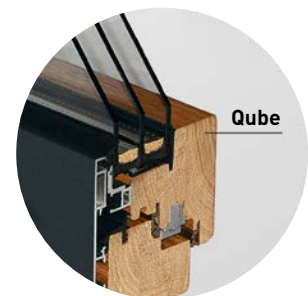

Qube

Alutrend Qube
Two variants of internal finish: Standard (rounded), Qube (angular)

*For a reference window 1230 mm x 1480 mm with $U_g=0.5W/m^2K$ glass

Timber-aluminum systems suitable for passive architecture



Alutrend Miratherm
Construction depth of 126 mm,
Uw from 0,70 W/m²K.



Ultratherm Basic
Construction depth of 122 mm,
Uw from 0,67 W/m²K.



Ultratherm Ultima
Construction depth of 125 mm,
Uw from 0,69 W/m²K.



*For a reference window 1230 mm x 1480 mm with Ug=0.5W/m²K glass

Aluminum cladding colours

Alutrend windows from the inside are coated as per our timber systems (page 7). The aluminum cladding from the outside can be powder coated in any standard RAL colour or in one of a range of more exclusive textured or wood effect finishes.



NOTE! The printed representations of the colours samples may visually differ from the actual product.

Aluminum Windows

- Wide spectrum of construction options: windows, doors, sliding systems, folding systems, pivot windows, fire-resistant and smoke control doors
- Exceptional thermal parameters
- High durability
- Full RAL palette, wood grain finishes, structural coatings, dual colours
- Double and triple glazing
- Warm spacer



MB 45
Construction depth of 45 mm.



MB 70 HI
Construction depth of 70 mm.

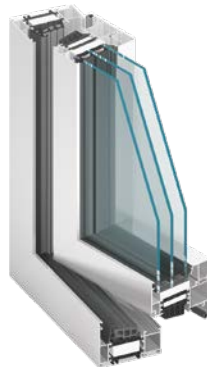

MB 86 Aero
Construction depth of 77 mm.



MB 104
Construction depth 95 mm. Passive house certified product, U_w from 0.53 W / m²K.



MB Slide
System MB-SLIDE is designed for the manufacture of thermally insulated doors and sliding windows.



SLIMLINE
Modern system with minimalistic profiles. Excellent thermal and acoustic performance. Perfect for modern architecture.



FERROLINE
Modern system with classical appearance designed to imitate traditional steel joinery.

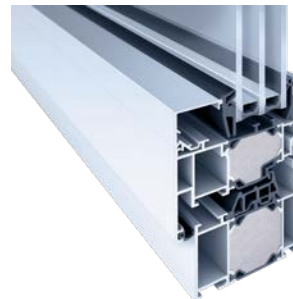

W 72
Construction depth 72 mm. Modular system with highly flexible design capabilities. Enhanced anti-security enabling classification up to RC3 standard.

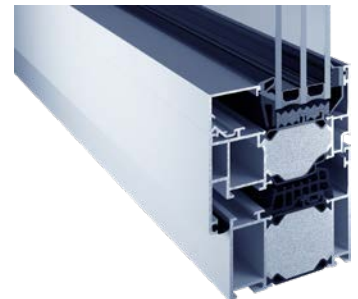

W 77
Also available as passive certified W77 HI variant. Enhanced security enabling classification up to RC4 standard (with stainless steel external security shutters RS 37 RC3).

Aluminum and timber-aluminum curtain walls



MB-SR 50
Aluminum curtain walls.

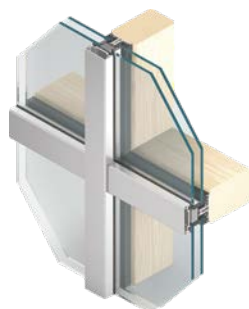

MB-SR 50 A
Timber-aluminum curtain walls.



MB-SR 50 Efekt
Semi structural glazing curtain walls.

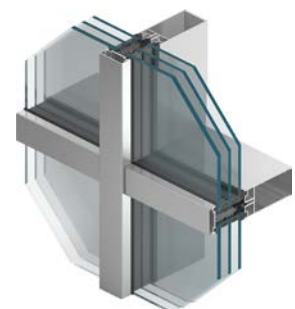

MB TT 50
Modern aluminum facade system with high thermal performance.

*For a reference window 1230 mm x 1480 mm with $U_g=0.5W/m^2K$ glass

External doors

- Extensive selection of models and designs, we use a variety of systems and materials: PVC, PVC-aluminum, timber, timber-aluminum, aluminum
- Highest quality products ensuring security, functionality, aesthetics, and exceptional thermal and acoustic performance
- Wide range of finishes: decorative glass, ironmongery, selection of handles and pull-handles
- Bespoke solutions on request



Aluminum doors for passive buildings



Timber doors



PVC doors



Flush panel PVC doors



Aluminum doors



Flush panel aluminum doors



Timber doors



Timber-aluminum doors

Fire resistant and smoke control doors



MB 78 EI

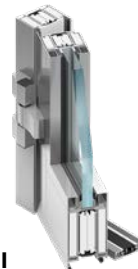

WICSTYLE 77 FP



Internal doors

- Timber doors, MDF doors in classical and modern designs
- Solid core, glazed and full glass doors
- Standard and flush closing doors, also available with hidden hinges
- Sliding and pocket doors



Roller-shutters and facade blinds

- Roller shutter boxes concealed in wall and external aluminum boxes
- Blinds and guiderails in both PVC and aluminum
- Somfy control technologies
- Intelligent building system control (TaHoma)
- Tape or crank handle operation
- Wide selection of colours (including wood grain finish)



Roller-shutter box PVC TOP DUO



Roller-shutter box TOP PSI suitable for passive architecture



Aluminum roller-shutter box, rounded, typically mounted on a wall



Aluminum roller-shutter box, square, typically mounted under a lintel



Multi-channel remote control



Tahoma Premium with security base



External facade venetian blind



TOP PSI box with a venetian blind



Shutters

- External and internal
- Wide selection: solid core, fixed and movable louvres
- Fitting systems supplied by renowned manufacturers



Terrace systems

- Tilt and slide systems (PSK)
- Lift and slide systems (HST)
- Fold and slide systems
- Veranda systems
(allows handle and cylinder both sides)
- Balcony windows

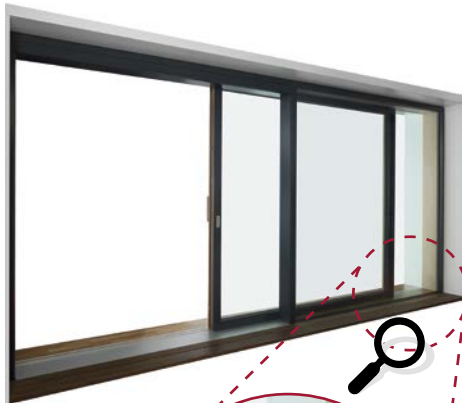

HST Panorama

Option where fixed glazing is in line with floor level.

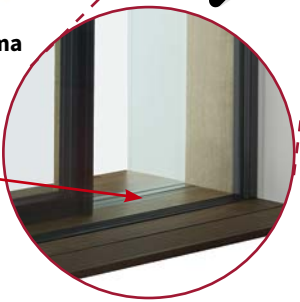

Artline
- slim sightline



Artline / Artline XL

Thermally insulated sliding door system with a slim sightline near the meeting stile (26 or 38 mm).



PSK doors



Fold and slide doors

Accessories

- Window ventilators
- Decorative glass
- Glazing bars: inter-sheet, adhered, vienna, cut into glass
- In-between-glass venetian blinds
- Alarm contacts
- Handles
- External and internal sills
- Window/door trims
- Automation, control systems
- Biometrics, keypads, intelligent building solutions
- Timber staircases
- Full glass constructions
- Insect screens



Garage doors

- Wide range of models and designs with a selection of accessories
- Variety of colours and surface finishes
- Manual or automated control
- High security



K2 RFS 60
Panel depth 60 mm, U=0,9 W/m²K.



K2 RC
Panel depth 40 mm, U=1,12 W/m²K.



K2 RS
Panel depth 40 mm, U=1,12 W/m²K.



K2 RF
Panel depth 40 mm, U=1,12 W/m²K.



K2 RM
Panel depth 40 mm, U=1,12 W/m²K.



K2 RA
Panel depth 40 mm, U=1,12 W/m²K.

Basic colour palette

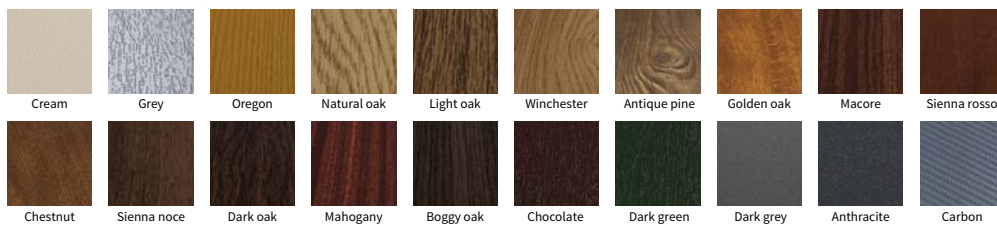

Extended colour palette

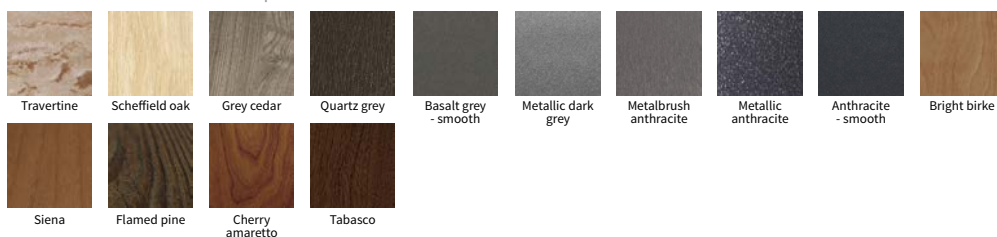

NOTE! The printed representations of the colours samples may visually differ from the actual product.

Professional installation accessories

UWE also supplies products for professional “warm” installation:

- internal and external membranes
- expanding tapes
- Thermo WOOD installation system
- MOWO installation system
- projecting window installation systems
- XPS warm window sill support

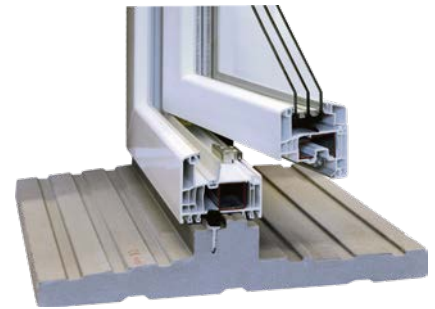

XPS window sill support

References

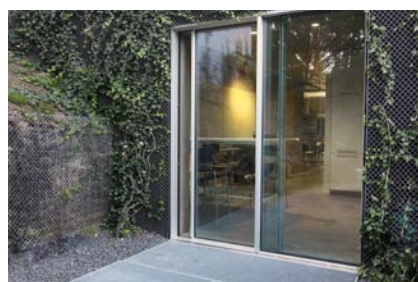
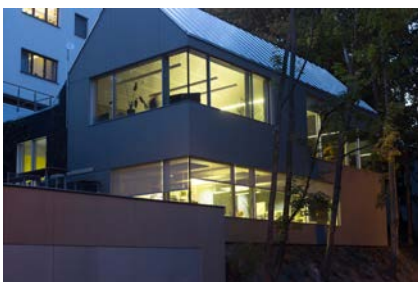



...you will understand the difference.

E: Kai@uwewindowsanddoors.com

P: (203) 667-1187