

Entrance Doors

Aluminum and PVC

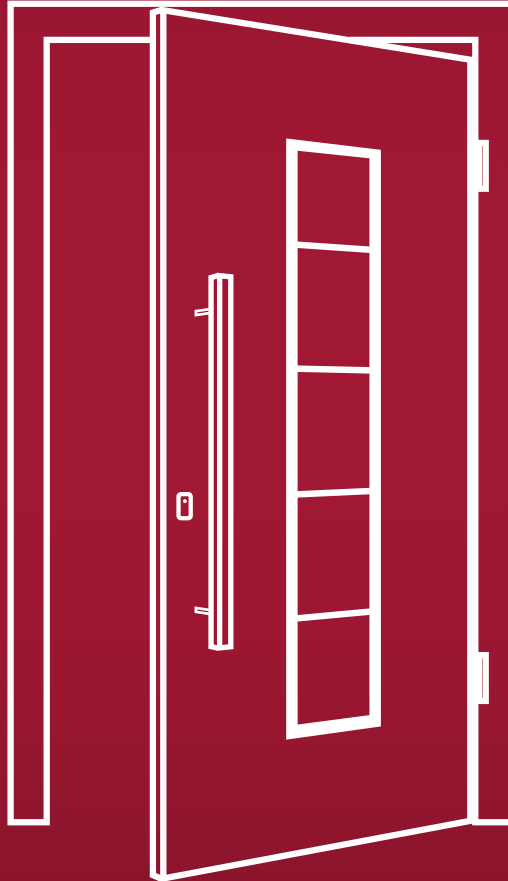

Quality | Security | Prestige | Comfort



...you will understand the difference.



Tradition of Quality since 1969.

Why UWE-B?

Because UWE-B have been building up their brand since 1969. In that time we have quenched the dreams of our numerous customers in Poland, Europe and worldwide. UWE-B is a renowned manufacturer of windows, doors and curtain walls. We are very proud to have earned the respect of investors in a variety of sectors: residential, commercial, historical restoration, and even the most demanding field of passive and energy efficient construction.

What is the highest quality of products a result of?

The highest quality of our products is achieved by the use of the most up-to-date technologies and continuous investments into R&D. Being one of the few manufacturers in Poland to have successfully introduced modern solutions into the market making us a pioneer of innovation and development within this sector. The quality, safety and comfort of our products are confirmed by numerous prestigious awards and certificates.

Why is UWE offer so comprehensive?

So you don't waste any of your precious time. You can choose from a wide range of materials: PVC systems, variety of timbers ranging from traditional pine to exotic species from around the world, aluminum systems as well as composite systems of PVC-aluminum and timber-aluminum. To complement our range of windows and doors you can choose from a vast spectrum of accessories e.g. roll-er-shutters, venetian blinds, insect screens, shutters, garage doors or even marquises or full glass constructions. We also offer numerous modern control systems e.g. radio, internet or biometrics.



Where to start?

Call us, send us an email or visit us
...you will understand the difference.

Contact information on rear of catalogue.

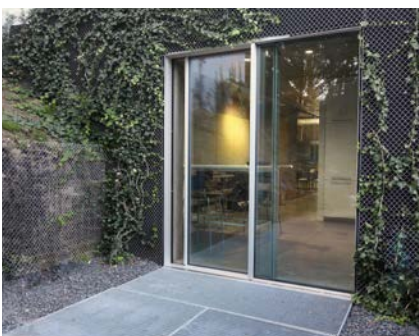
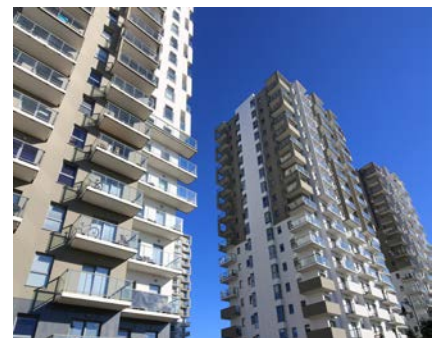
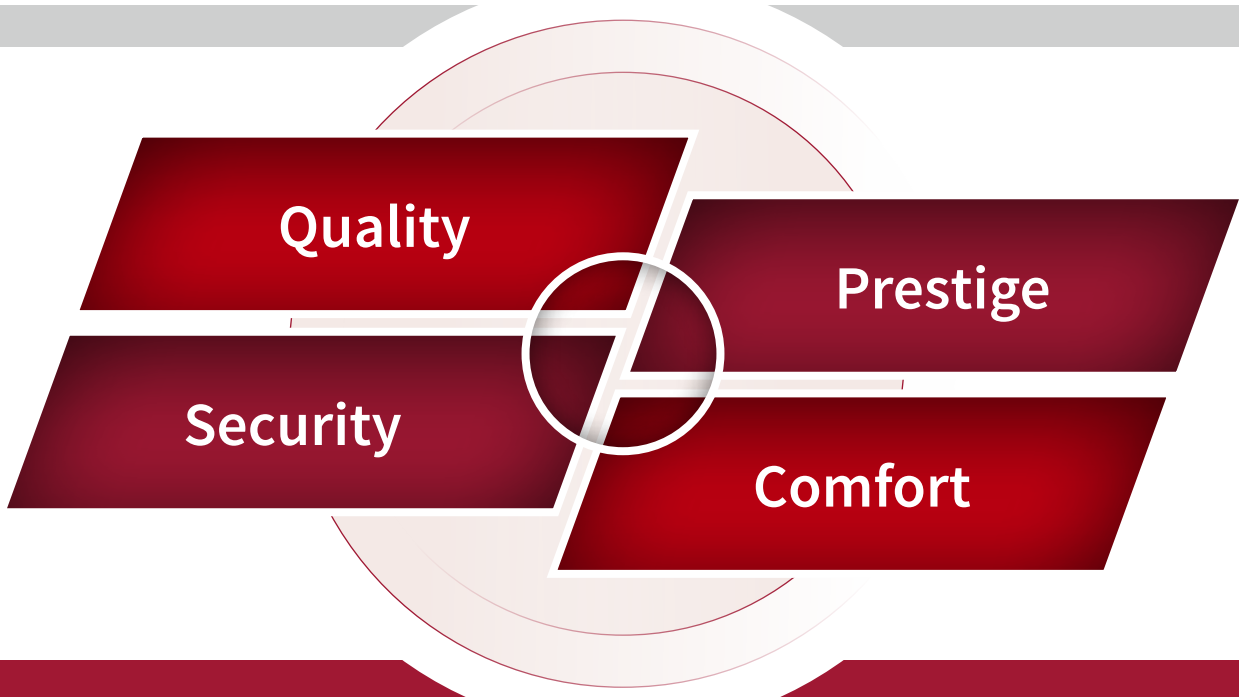

Aluminum Doors. Benefit primarily from a modern design and exceptional resistance to the external elements. Aluminum is a technologically advanced material whose performance is clearly demonstrated by its use for the fabrication of aircraft parts. Production time for aluminum doors is fast so you don't have to wait long for your door. And a wide range of designs allow you to select the door of your dreams.



Alu-Inox applications on the aluminum doors are flush mounted into the surface of the door. Applications and milled grooves are present on the exterior of the door as standard.



Available variant types:

	Inserted	Exterior flush panel	Flush panel both sides
MB 70	✓		
MB 86	✓	✓	✓



Available variant types:

	Inserted	Exterior flush panel	Flush panel both sides
MB 70	✓		
MB 86	✓	✓	✓

BB_ALU_03



Available variant types:

	Inserted	Exterior flush panel	Flush panel both sides
MB 70	✓		
MB 86	✓	✓	✓

BB_ALU_04



Available variant types:

	Inserted	Exterior flush panel	Flush panel both sides
MB 70	✓		
MB 86	✓	✓	✓

BB_ALU_05



Available variant types:

	Inserted	Exterior flush panel	Flush panel both sides
MB 70	✓		
MB 86	✓	✓	✓

BB_ALU_06



Available variant types:

	Inserted	Exterior flush panel	Flush panel both sides
MB 70	✓		
MB 86	✓	✓	✓



BB_ALU_07

Available variant types:

	Inserted	Exterior flush panel	Flush panel both sides
MB 70	✓		
MB 86	✓	✓	✓



BB_ALU_08

Available variant types:

	Inserted	Exterior flush panel	Flush panel both sides
MB 70	✓		
MB 86	✓	✓	✓



BB_ALU_09

Available variant types:

	Inserted	Exterior flush panel	Flush panel both sides
MB 70	✓		
MB 86	✓	✓	✓



BB_ALU_10

Available variant types:

	Inserted	Exterior flush panel	Flush panel both sides
MB 70	✓		
MB 86	✓	✓	✓

PVC doors guarantee a high level of thermal insulation and excellent user comfort. Their high performance insulation is achieved by the incorporation of our Kombi system profiles, whose benefits can also be appreciated in our corresponding window systems. The PVC doors presented are the most sensible choice for people looking for a comfortable solution at an exceptional price.



Alu-Inox applications on the PVC doors are surface mounted (raised above the surface of the door). Applications are on both sides of the door.



BB_PVC_03



Available variant type:

Inserted

Kombistystem



BB_PVC_04



Available variant type:

Inserted

Kombistystem



BB_PVC_05



Available variant type:

Inserted

Kombistystem



Standard colours for aluminum doors:



Painted white both sides

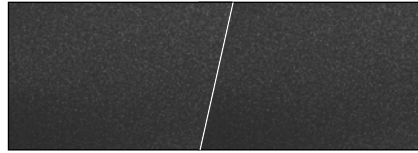

Painted in DB 703 both sides



Painted in RAL 7016 both sides



Painted in DB 703 on outside and white on inside



Painted in RAL 7016 on outside and white on inside

Standard colours for PVC doors:



White both sides



Anthracite decorative adhered foil (grained structure)
White on inside

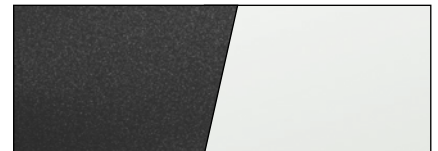

DB 703 on outside (adhered foil)
White on inside

Note! Printing and graphic technologies used in this catalogue can result in colour variation in relation to the real products.

Door opening directions

DOOR OPENING LEFT TO THE OUTSIDE

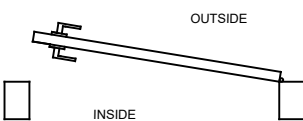

DOOR OPENING RIGHT TO THE OUTSIDE

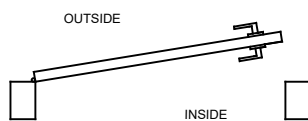

DOOR OPENING LEFT TO THE INSIDE

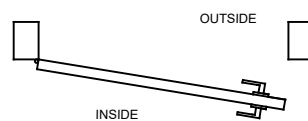

DOOR OPENING RIGHT TO THE INSIDE

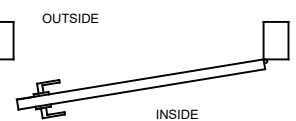

Available variants of aluminum door

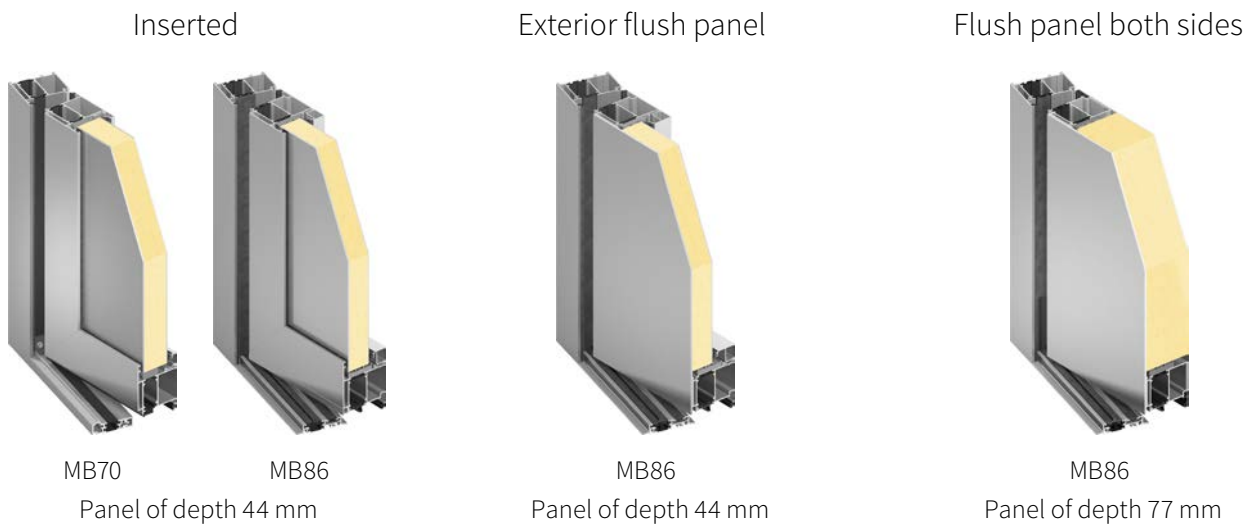

Variant cross-sections

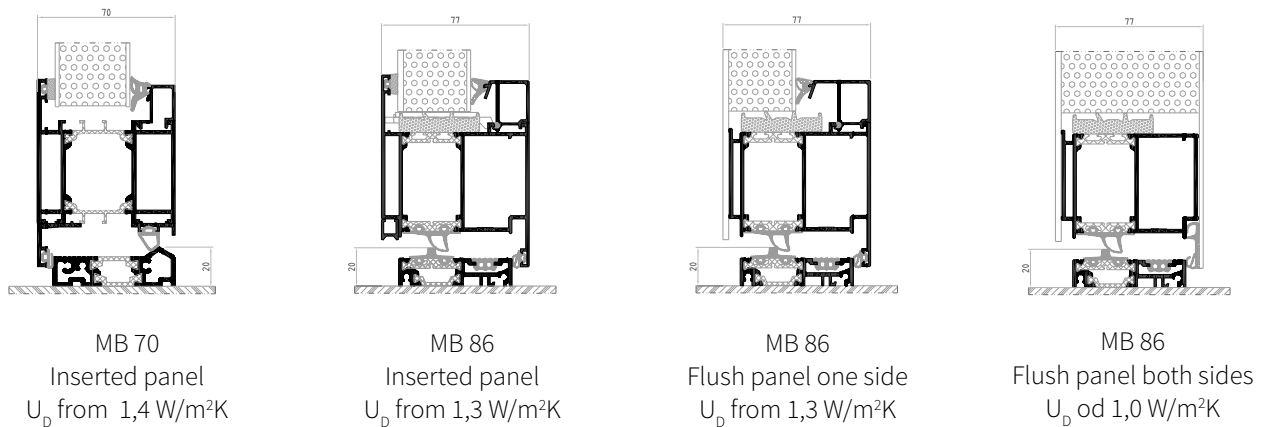

Available variants of PVC door PVC door cross-sections

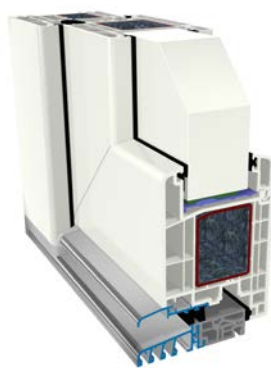

KOMBISYSTEM Inserted panel
Panel depth 44 mm

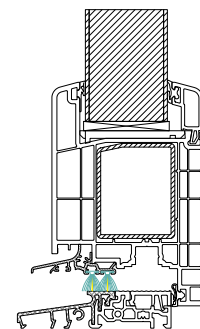

KOMBISYSTEM Inserted panel
 U_D from 0,86 W/m²K



External security Rosetta
(stainless steel)

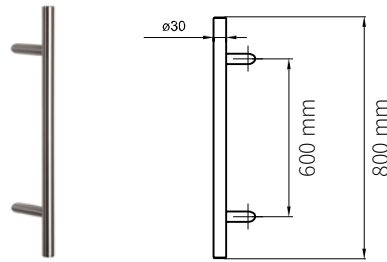

External pull bar – straight with 45° mounting
(stainless steel), length 800 mm



Internal handle with long backplate
ALU: stainless, white, silver, EV1-anodised
PVC: stainless, white, silver, EV1-anodised silver silver



Surface mounted hinges
for aluminum doors

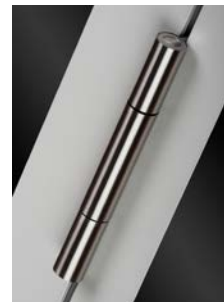

Barrel hinges
for aluminum door



Surface mounted hinges for PVC doors

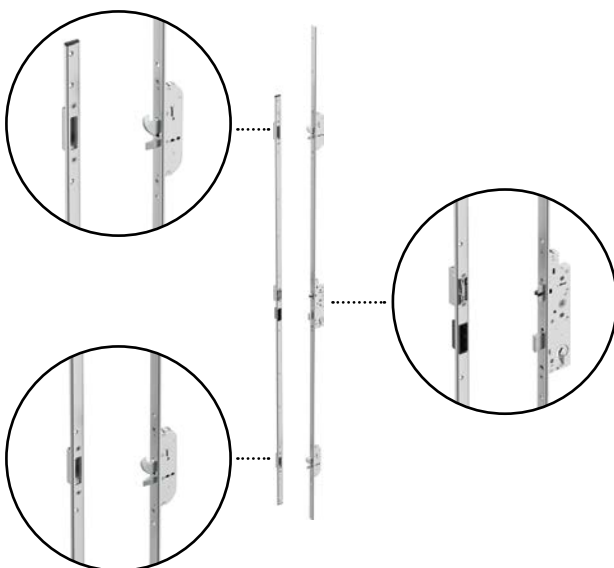

3 point espagnolette – with hooks

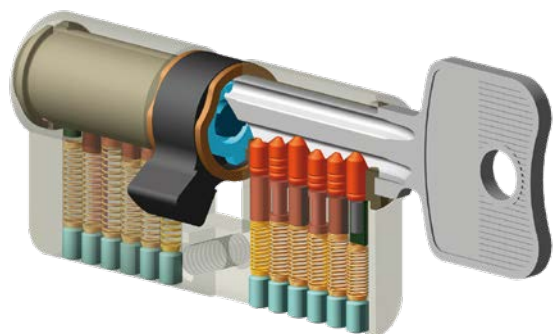

Class A cylinder

Aluminum and PVC door equipment

DOOR EQUIPMENT	Standard	Options (does not change delivery time)
Door colours listed in the catalogue	✓	
External security Rosetta (stainless steel)	✓	
Pull bar – straight with 45° mounting (stainless steel), length 800mm (colours shown in catalogue)	✓	
Handle with long backplate, from inside in colour option listed in catalogue.	✓	
Handle with long backplate, both sides		✓
Surface mounted hinges	✓	
Barrel hinges (stainless steel)		✓
3 point espagnolette with hooks	✓	
Espagnolette MACO Z-TF		✓
Cylinder lock class A	✓	
2 security bolts		✓
Glazing in panel, clear float	✓	
Glazing in panel, matt		✓
Glazing in panel, chinchilla		✓
Glazing in panel, mastercarre		✓
Glazing in panel, masterpoint		✓
Glazing in panel, satinato		✓
Glazing in panel, masterligne		✓
ALUMINUM DOOR IN SYSTEM MB 70		
Inserted panel (44 mm depth)	✓	
Maximum door dimentions 1250 x 2550 mm		
ALUMINUM DOOR IN SYSTEM MB 86		
Inserted panel (44 mm depth)	✓	
Flush panel from outside (44 mm depth)	✓	
Flush panel both sides (77 mm depth)	✓	
Maximum door dimentions 1250 x 2550 mm		
PVC DOOR IN KOMBISYSTEM		
Inserted panel (44 mm depth)	✓	
Maximum door dimentions 1200 x 2360 mm		

External Doors

- Extensive selection of models and designs, we use a variety of systems and materials: PVC, PVC-aluminum, timber, timber-aluminum, aluminum
- Highest quality products ensuring security, functionality, aesthetics, and exceptional thermal and acoustic performance
- Wide range of finishes: decorative glass, ironmongery, selection of handles and pull-handles
- Bespoke solutions on request



Aluminum doors for passive buildings



Timber doors

Fire resistant and smoke control doors

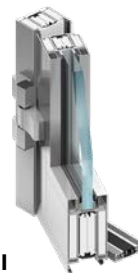

MB 78 EI



WICSTYLE 77 FP

Internal doors

- Timber doors, MDF doors in classical and modern designs
- Solid core, glazed and full glass doors
- Standard and flush closing doors, also available with hidden hinges
- Sliding and pocket doors



Glass door leaves

Glass door leaves with timber frames are a best seller of Bertrand's. Modern designs lead to this being an ever more popular product in our extensive range. These doors are formed by combining dedicated fittings manufactured by the specialist company Dorma and toughened safety glass. We offer a wide range of glass designs. Frames can be manufactured from a wide range of timber species.



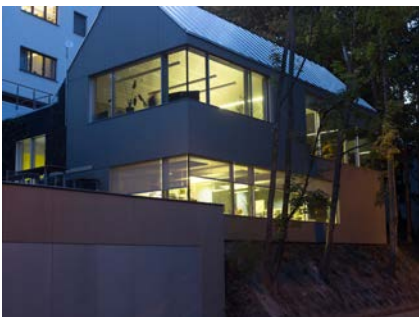

Modern buildings



Historic buildings



Modern buildings



Modern buildings



Historic buildings



Apartment buildings



Aluminum facades



Big projects



Family houses



...you will understand the difference.

